



FP8YLI-B

Landscape installation yoke for FlexPoint FP8

Features

- Landscape yoke for fixed installations
- Stand mount when used with pole mount adaptor ASF20045 (available separately)
- Truss mount when used with a third-party half-coupler
- Allows close proximity mounting
- Central hole: 12 mm (0.47 in); two inner holes: 8.2 mm (0.32 in); two outer holes: 6.2 mm (0.24 in)
- Available in black

Applications

- Installed flown FlexPoint FP8
- Installed wall or ceiling mounted FlexPoint FP8
- Installed pole mounted FlexPoint FP8

Contents

- 1 x FP8YLI-B yoke
- 2 x M10 x 30 hex bolts
- 2 x M10 spring washers
- 2 x M10 flat washers

Technical Specifications

Weight: 2.12 kg 4.67 lb
Material: Weatherised polyester powder coated steel

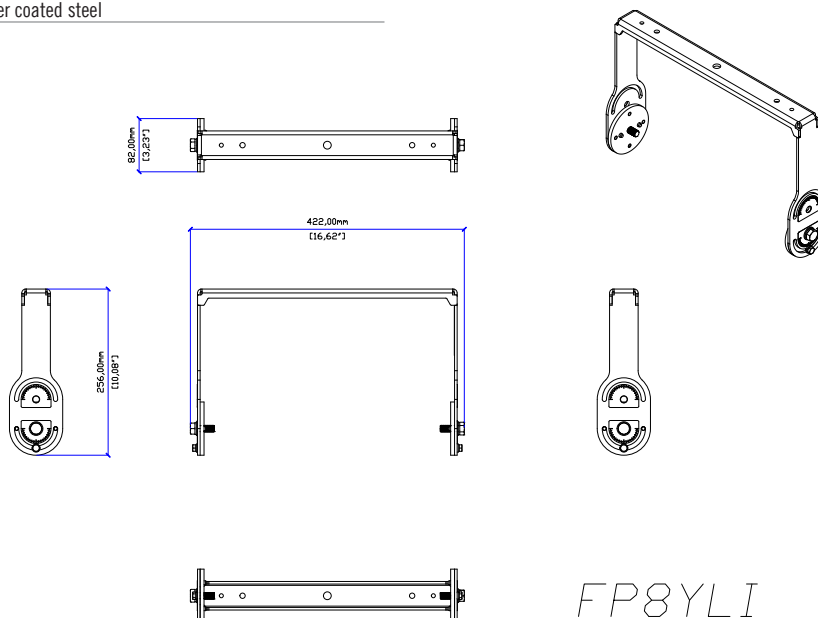

FP8YLI